



THE CANADIAN

COMPLETE TRANS-CANADA EXPERIENCE

The Empire Builder • Vancouver • Jasper • Icefields Parkway • Banff • Montréal • The Canadian • The Lake Shore Limited

Travel 2200 miles across seven northern U.S. states on the **Empire Builder**, one of Amtrak's trains. You will be treated royally on this fabulous train.

Vancouver is one of North America's most prosperous cities and one of its most beautiful. We'll embark on a three-and-a-half hour sightseeing tour of the city including Gastown, Chinatown, Stanley Park, English Bay, Marine Drive, the waterfront and Queen Elizabeth Park.

The **Vancouver Aquarium** is home for more than 8000 marine animals. They represent such diverse habitats as Arctic Canada and the Amazon Rain Forest.

Travel 2700 miles aboard VIA Rail Canada's **Canadian** between the towering **Canadian Rockies**, across the vast Prairie and through the **Canadian Shield** to **Toronto**.

Experience **Icefields Parkway**, North America's most scenic highway. Another high point will be a visit to **Lake Louise** and its famous Chateau.

A great conclusion to your tour will be a fast run on VIA from Toronto to Montréal and a ride along **Lake Champlain** on Amtrak's **Adirondack**, described as one of the top ten scenic train rides in the world!

A VALID PASSPORT IS REQUIRED FOR THIS TOUR

Days 1-3 Chicago to Vancouver
 Day 4..... Vancouver
 Day 5..... En Route
 Day 6..... Jasper
 Days 7-8 Icefields Parkway /
 Banff

Day 9..... Depart Jasper
 Days 10-11 En Route
 Day 12..... Montréal / En Route
 Day 13..... En Route to Chicago

TOUR DATE(S):

2017

Sat., May 6 to Thurs., May 18

Sat., Oct. 21 to Thurs., Nov. 2

TOUR PRICE:

All prices are per person / double occupancy unless otherwise stated.

\$4,795 - 13 Days

Upgrade: Bedroom + \$845

SINGLE \$5,795

FLY OPTION: Fly to Seattle, return from Albany.
10 Days

Price: \$3,995

Single: \$4,495

America by Rail will be happy to arrange your flights. Airfare is not included in above price.

YOUR TRIP INCLUDES:

- Round-trip transportation by rail from Chicago.
- Private-room sleeping accommodations on the Amtrak trains for three nights in private Roomettes. Travel VIA Rail in a Cabin for four nights. (Travel in a Berth and save \$400 per person, see Page 33 for a description of VIA accommodations.)
- First-class hotel accommodations for five nights.
- 20 meals.
- Extensive sightseeing including and admissions to the Sulphur Mountain Gondola.
- Baggage handling, taxes & tips.
- Services of a professional America by Rail Tour Director.

AMERICA BY RAIL WILL BE HAPPY TO MAKE ARRANGEMENTS FOR YOUR CONNECTING TRANSPORTATION TO CHICAGO AND BACK BY RAIL OR AIR.

Day 1: Depart Chicago

Complete Trans-Canada Experience tour members will meet the Tour Director in the Metropolitan Lounge at Chicago's Union Station throughout the morning. We'll board Amtrak's Empire Builder, a double-decker, Superliner-equipped train, in time for its afternoon departure. This famous train will carry us across seven northern states to Seattle, Washington.

Relax in your comfortable private Roomette sleeping accommodations. Bedrooms are available at an additional cost.

After settling in, you may want to go to the glass-walled Sightseer Lounge car for spectacular viewing of the passing scenery. All full-course, tastefully prepared, dining car meals are included. **D**

Day 2: En Route

This morning we cross the remote flatlands of western North Dakota and eastern Montana. The agricultural landscape continues until mid afternoon. **B, L & D**

Day 3: Seattle / Vancouver

You may want to rise early to watch the sun come up over some spectacular scenery. This morning the Empire Builder will enter the 7.8 mile-long Cascade Tunnel. For the next several hours we'll wind through the scenic

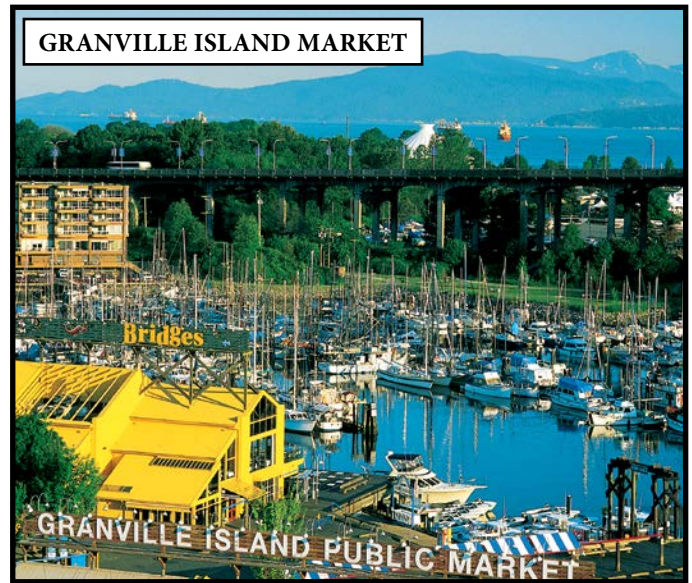

Cascade Mountains. Finally, we roll south through the lush Puget Sound area and ease into the Seattle train station.

We'll board our deluxe motorcoach for a sightseeing tour of the Seattle area. It will include Chinatown, concrete floating bridges, Lake Washington, the arboretum, the University of Washington, plus sweeping views of Puget Sound and the Olympic Mountains. We will also visit the famous Seattle Space Needle, with incredible photo opportunities from the observation deck and Pike Place Market.

We will continue on to Vancouver, one of North America's most prosperous cities and one of its most beautiful.

We will check into the deluxe Blue Horizon Hotel, our home tonight. The hotel is convenient to many of this great city's major attractions. **B**

Day 4: Vancouver

This morning we'll embark on a three-

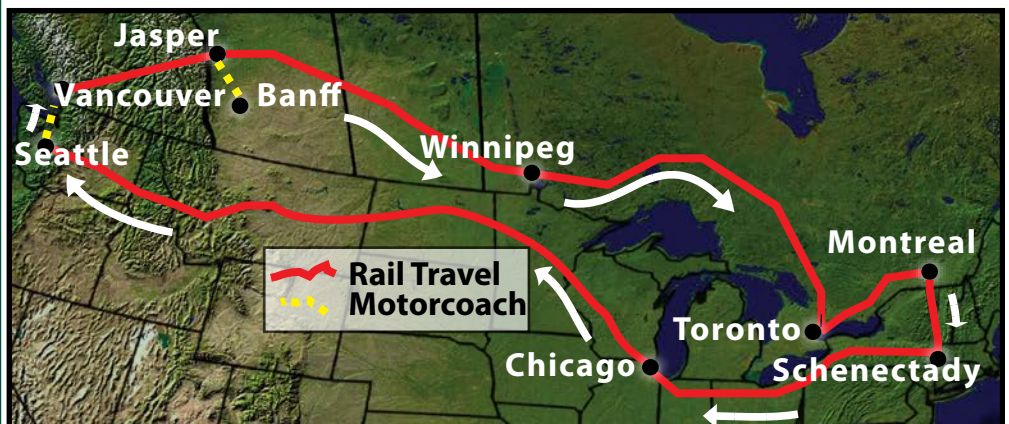

and-a-half hour sightseeing tour of the city. The tour will include Gastown, Chinatown, Stanley Park, English Bay, Marine Drive, the waterfront and Queen Elizabeth Park with an “on-your-own” lunch stop at Granville Island.

This afternoon we will visit the world-famous Vancouver Aquarium. More than 8,000 marine animals are featured. They represent such diverse habitats as Arctic Canada and the Amazon Rain Forest. The ocean floor and its inhabitants can be viewed through the simulated portholes of a submarine in the North Pacific Gallery. A whale show and shark dive are also offered.

This evening we'll transfer to The Keg Steakhouse for an included dinner.

Following our leisurely dinner we'll transfer to the VIA Rail Station to prepare for our 8:30 p.m. departure. We're about to embark on one of the world's greatest passenger rail experiences . . . The Canadian! For four days and nights we'll travel 2700 miles between the towering Canadian Rockies' peaks, across the vast Prairie Plains and through the Canadian Shield wilderness on our way to Toronto. We'll, of course, stop over in the heart of the Rockies for three days before continuing our eastbound journey. Enjoy a welcome reception in the lounge car upon departure. Relax in the comfort of your private cabin. **D**

Day 5: En Route

All meals aboard The Canadian are included in the elegant, art deco dining car. You'll want to rise early this morning to enjoy breakfast in the dining car. Afterward you'll want to head for one of the all-glass, bubble-top Vistadomes. You may be fortunate enough to catch the sun rising over the brilliant peaks and pine forests of the Canadian Rockies. What a thrilling rail journey you'll experience today! Our train will wind between some of the highest peaks in the Canadian Rockies.

The most stunning scenery of the day will be experienced as we follow the Miette River toward Jasper; first Mount Robson, the highest peak in the Canadian Rockies, comes into view and then we'll roll through Yellowhead Pass.

We'll arrive in Jasper at 4:00 p.m. and transfer across the street to the conveniently located Whistlers Inn. The

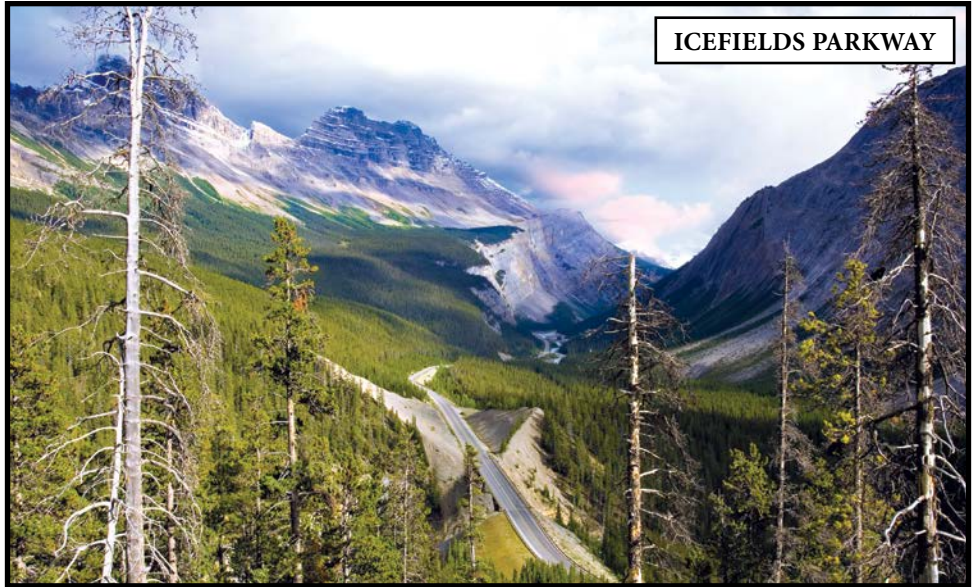

ICEFIELDS PARKWAY

Inn is located in the heart of Jasper, close to shops and restaurants. **B & L**

Day 6: Icefields Parkway / Banff

Today travelers will experience the Icefields Parkway, North America's most scenic highway.

Another high point will be the visit to Lake Louise and its famous Chateau. The setting is one of the most picturesque in the Rockies. A boxed lunch will be served en route. We will arrive in Banff late this afternoon. Our lodging for two nights will be the conveniently located Banff Aspen Lodge. **L**

Day 7: Banff

This morning we'll embark on a

Discover Banff Tour. The highlight of the tour will be the gondola ride to the top of Sulphur Mountain for a spectacular view.

You're free this afternoon to rest, shop along Banff Avenue, or visit the Natural History or Parks Canada Museums. **CB**

Day 8: Depart Banff

This is one of the rare tours that allows you to experience the Icefield Parkway in both directions. We'll depart Banff this morning and arrive at the Jasper VIA Rail station at mid afternoon. We'll board the Canadian and depart for Toronto at 5:30 p.m. Enjoy all of the fantastic amenities of this world-class train. **CB & D**

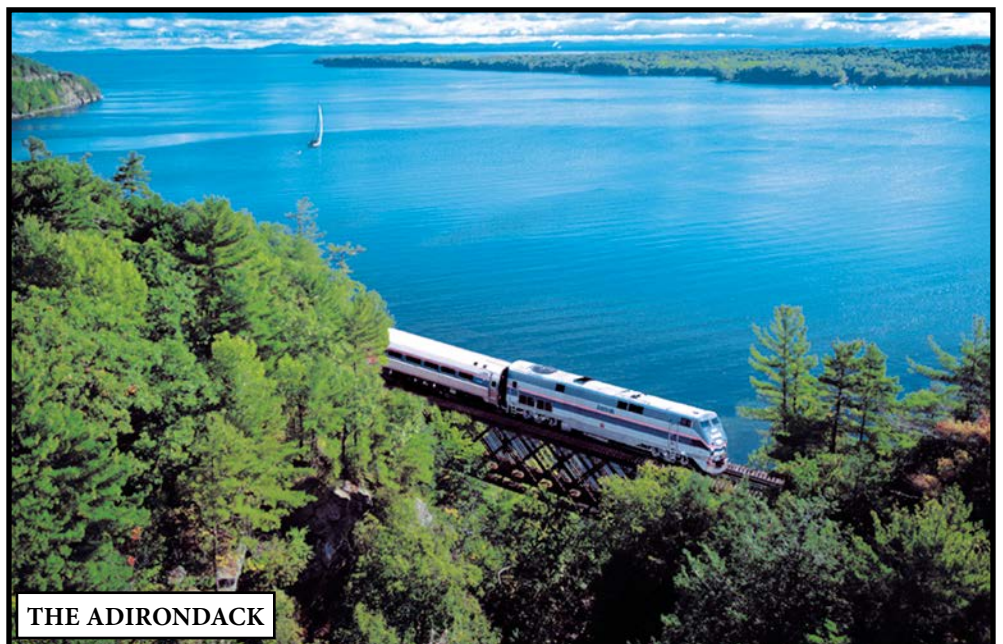

THE ADIRONDACK

Day 9: En Route

Three great meals, onboard activities and the Great Plains of Canada are all highlights today. At 8:30 p.m. we'll arrive in Winnipeg where you can stroll "The Forks". The Forks features a vast array of dining and shopping opportunities... Just make sure you are back in plenty of time for the 10:30 p.m. departure. **B, L & D**

Day 10: En Route

Today's scenery may be the best yet as we discover the fascinating, rugged landscape of Northern Ontario. Our train will wind between countless pristine lakes and rock protrusions created by the last great glacier. **B, L & D**

Day 11: Toronto / Montréal

We'll arrive in Toronto's Union Station at 9:30 a.m.

At 11:30 a.m. we will board one of VIA Rail's swift trains to Montréal. Arrival is scheduled for 4:47 p.m. We will check into the Hotel Bonaventure in May, (the Fairmont Queen Elizabeth in Oct.). **B**

Day 12: En Route

This morning we'll descend into the VIA Rail Station and prepare to board Amtrak's Adirondack for our 10:20 a.m. departure for the 222-mile run along Lake Champlain and the beautiful Adirondack Mountains. This has been described as one of the top ten scenic train rides in the world!

Arrival into Schenectady is scheduled for 5:27 p.m. You will board the Lake Shore Limited for the 7:32 p.m. departure for Chicago. Eastern passengers will remain on the train until 5:57 p.m. when the train reaches Albany.

Day 13: En Route to Chicago

This morning we are scheduled to arrive into Chicago at 9:45 a.m. Passengers will continue to home destinations throughout the day. Eastern people will depart Albany for home destinations. **B***

*Midwest tour members only.

**Book a Berth
on VIA and save!**

VIA RAIL ACCOMMODATIONS

THE CABIN FOR ONE is a private room with a wide window designed for one person. A comfortable sofa chair by day converts to a single bed at night. The room is approximately 6' 5" x 3' 7.5". The mattress is approximately 5' 11" x 2' 6". There is a toilet (bed covers toilet at night), a sink and full mirror. A shower is located in the same car.

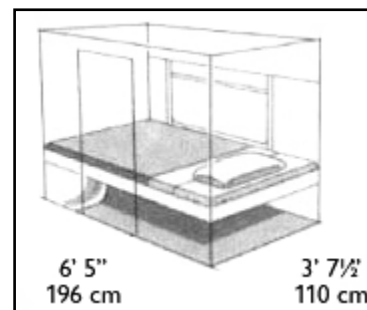

THE CABIN FOR TWO is a private room with a wide window designed for two people that includes a private restroom. The room features two comfortable folding chairs by day and an upper and lower bed at night. The room is approximately 7' 3" x 4' 11" (not including the private restroom). Mattresses are approximately 71" x 31". A shower is located in the same car.

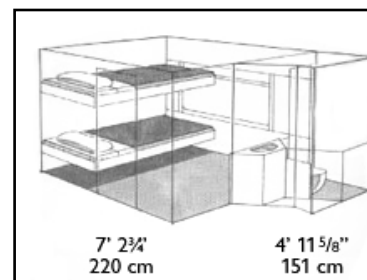

THE BERTH - Remember those Pullman Cars in the old movies? Each berth is designed for one person. A Berth may be lower or upper (there is a ladder). By day one wide couch-style faces another (the other berth's seat) with a large window between. At night the seats become the upper and lower berths with heavy curtains (now do you remember the movies?) The mattress is approximately 5' 10" x 3' 7"; the foot end has a 10" radius. These are actually the widest beds on the train. Restroom and shower facilities are located in the same car. Berths are a great value if you don't mind the lack of privacy during the day.

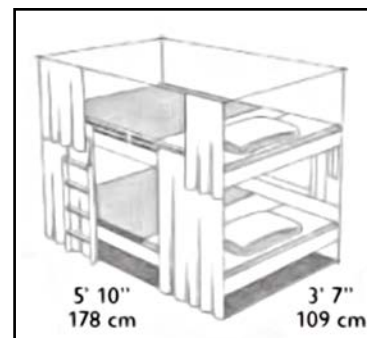

GENERAL INFORMATION

REGISTRATION AND DEPOSIT:

A deposit of \$200 per person, of which \$100 per person is non-refundable, is required to finalize registration. The balance is due 75 days prior to departure. If payments are not received by the due date(s) specified, reservations may be cancelled without notice.

TOUR CANCELLATIONS:

If cancellation is received by America by Rail more than 75 days prior to departure, \$100 of your deposit will be retained. For cancellations received within 75 days of departure, the following per person cancellation fees apply:

- 46-75 days prior to departure: 25% of total tour cost.
- 15-45 days prior to departure: 50% of total tour cost.
- 14 days or less prior to departure through duration of the tour: 100% of total tour cost.

The total tour cost includes tour price, add-ons and upgrades.

Refunds will be made approximately 30 days after the conclusion of the tour.

Payment / cancellation exceptions are noted on tours. All pricing is per person / double occupancy unless otherwise stated.

TOUR PRICE INCLUDES:

TRANSPORTATION

Rail transportation over the tour route and motorcoach, van, or other modes of transportation where specified in the tour.

TRAIN ACCOMMODATIONS

All tours except those categorized as Coach Class include private Roomette on Amtrak overnight trains and Bedrooms (double occupancy) or Roomettes (single occupancy) on VIA Rail Canada overnight trains.

Bedrooms on Amtrak are available at an additional cost. Reclining coach seats are included on U.S. and Canadian trains used only during the daytime except for those categorized as Coach Class. Coach Class tours include reclining coach seats with leg rests on Amtrak trains. Meals on the trains are included for those traveling Coach Class on the North American tours as indicated in the itinerary.

HOTELS

Accommodations are based on two persons sharing a room. Two-bedded rooms are provided in most instances. However, sometimes their availability is limited. If a two-bedded room is required, please notify America by Rail at time of registration.

America by Rail reserves the right to substitute hotels for those named in any tour description, when necessary. Every effort is made to have hotel rooms available for occupancy upon arrival. There may be instances when rooms are not available until later.

SINGLE ROOMS

Single rooms at hotels and Amtrak Roomettes on a single basis are available at a single cost.

SIGHTSEEING / ADMISSIONS

Sightseeing, as outlined in the itineraries, will be provided by motorcoaches in most instances. Admission fees are included as specified. Sightseeing tour arrangements may be altered if required.

MEALS

All included meals are listed in the tour itinerary. Persons requiring a special diet must inform America by Rail at the time of registration. Not all restaurants / trains will be able to honor special requests. Due to events beyond our control, trains are sometimes delayed and supplies may become limited. If you have special dietary requirements, please make sure you have a sufficient supply of nourishment to meet your dietary needs.

In the itineraries, the meals are listed at the end of each day using CB for Continental breakfast, B for breakfast, L for lunch, and D for dinner.

BAGGAGE

For your convenience and to expedite movement, baggage handling is limited to one suitcase per person. Transfer and portage of one suitcase per person is included at

overnight stopovers. On most tours the one suitcase per person is handled by America by Rail and is checked through to the next destination. An overnight bag is used while en route. America by Rail is not responsible for loss or damage to your baggage or for any lost, stolen or destroyed item. Specified transfers between rail stations and hotels are included.

TOUR DIRECTORS

Services of a qualified America by Rail Tour Director are included for all matters pertaining to the tour. Tour Directors will meet all tour members at the origination city.

TIPS AND TAXES

All gratuities to hotel staff (except to chambermaids), sightseeing guides and drivers are included. Gratuities for sleeping car attendants and meals aboard the train are included. Gratuities for meals specified in the tour itinerary are included on escorted portions of the tour. Gratuities for cruise ship stateroom stewards and dining waitstaff are included.

TOUR PRICE DOES NOT INCLUDE:

Transportation and tips between your home city and the official origination city; charges for excess baggage; health, accident or baggage insurance; tips to chambermaids and for personal services; items of a personal nature such as laundry; meals, except those specified as included; gratuities for special services; charges for room service, and alcoholic beverages with included meals.

Gratuities for the America by Rail Tour Directors are at your discretion; \$3-\$10 per person per day is the industry standard. They should be extended on an individual basis, not as a group.

RAIL SCHEDULES:

The routing and features described in tour descriptions may be altered to adjust to rail schedules in effect at the time of the tour. America by Rail reserves the right to substitute motorcoach or air travel for unavailable rail schedules, misconnections, delays or other causes.

TRAVEL DOCUMENTS :

A valid passport will be required for any trip crossing international borders. i.e. into or out of the United States. At time of reservation we will need your date of birth; gender; passport number, passport expiration date and issuing country.

HEALTH, MOBILITY AND FITNESS TO TRAVEL:

America by Rail will make reasonable efforts to accommodate the special needs of tour participants. Such participants, however, should be aware that the Americans with Disabilities Act is inapplicable outside of the United States and facilities outside the United States for disabled individuals are limited. Any type of disability requiring special provisions must be reported to America by Rail at the time of registration. America by Rail is not required to provide participants with personal devices, such as wheelchairs or individually prescribed devices such as prescription eyeglasses, or to provide services of a personal nature including assistance in eating, toileting or dressing. Accordingly, all participants are responsible to participate without assistance of the America by Rail Tour Director or other attendant. Tour Directors are prohibited from providing physical assistance or accommodations (beyond normal civil courtesies, such as holding doors open for passing). It is recommended that participants requiring assistance, including those requiring the use of a mobility device, be accompanied by a travel companion who will be responsible to provide required assistance. Participants will be asked to submit a confidential medical form for each tour.

Those travelling with oxygen are required to advise America by Rail at least two weeks prior to departure. Amtrak requires all equipment, including oxygen concentrators, must be able to operate a minimum of four hours without available onboard electrical power (in the event of a power disruption onboard). Oxygen equipment must be Underwriter's Laboratory (UL) or Factory Mutual (FM) listed. The total weight of all tanks may not exceed 120 lbs. Within this limit, no more than 2

tanks 50 lb each, or no more than 6 tanks 20 lbs each

SMOKING:

Smoking is not permitted on America by Rail motorcoaches. Those who smoke may do so at any of the frequent stops we make. All Amtrak and VIA Rail trains are entirely smoke-free. If time is available at station stops, it will be announced by the conductor. Cruise ships policies vary from line to line, but all have designated areas to accommodate smokers.

PLEASE NOTE:

America by Rail reserves the right, at its sole discretion, to accept or retain any individuals as members of the tour. The acceptance of any service provided as part of an America by Rail tour, or any ticket or voucher, shall be deemed to be acceptance of and consent to these conditions.

All rates published herein are in U.S. dollars and based on tariffs and exchange rates in effect on the printing date of the tour brochure. Prices and arrangements are subject to change without notice.

No persons, other than a representative of America by Rail, authorized by a document in writing, may vary, add or waive any term or condition set forth in the preceding provisions.

A \$50 per person fee will be assessed for each itinerary alteration requested after final arrangements are confirmed.

It is our company policy to issue a tour roster to all tour participants containing all tour participants' names and addresses. If you do not want your address included, you must let us know at time of reservation.

Times, schedules, entertainment and activities are subject to change without notice.

IMPORTANT INFORMATION REGARDING FUEL SUPPLEMENT:

Please be advised America by Rail reserves the right to apply a fuel supplement for all guests should the price of oil warrant it.

RESPONSIBILITY CLAUSE:

America by Rail acts only in the capacity as an agent for the owners and contractors providing means of transportation, hotel or other services. All tour services, tickets and vouchers are subject to any and all terms and conditions under which such means of transportation, hotel or other services are offered or provided. America by Rail shall not be or become liable or responsible in any way whatsoever, for any loss, injury or damage from acts of God, sickness, theft, weather, strikes, war, or quarantine however caused or arising.

America by Rail reserves the right to cancel a tour in the event tour participation does not meet minimum requirements.

America by Rail shall not be obligated to honor any booking resulting from, nor shall be responsible or liable whatsoever in connection with, misprints or errors of any kind, whether in brochures, advertisements, on the Internet, during the booking process or otherwise, that result in traveler being undercharged for the tour. America by Rail reserves the right, prior to departure, to collect the correct fare or cancel the booking and refund any payment made by traveler.

AMTRAK STATEMENT:

The National Railroad Passenger Corporation (Amtrak) is not to be held responsible for any act, omissions, or event during the time passengers are not on board their trains or conveyance. The passenger contract in use of the National Railroad Passenger Corporation (Amtrak) when issued, shall constitute the sole contract between the National Railroad Passenger Corporation (Amtrak) and purchaser of these tours and / or passenger. All conditions are subject to the laws of the District of Columbia, U.S.A.

America by Rail® is the registered trademark of America by Rail, Inc.